

PolarHV™ HiPerFET Power MOSFET

IXFK 64N50P
IXFX 64N50P

$V_{DSS} = 500 \text{ V}$
 $I_{D25} = 64 \text{ A}$
 $R_{DS(on)} \leq 85 \text{ m}\Omega$
 $t_{rr} \leq 200 \text{ ns}$

N-Channel Enhancement Mode
 Avalanche Rated
 Fast Intrinsic Diode



Symbol	Test Conditions	Maximum Ratings	
V_{DSS}	$T_J = 25^\circ\text{C}$ to 150°C	500	V
V_{DGR}	$T_J = 25^\circ\text{C}$ to 150°C ; $R_{GS} = 1 \text{ M}\Omega$	500	V
V_{GSS}	Continuous	± 30	V
V_{GSM}	Transient	± 40	V
I_{D25}	$T_C = 25^\circ\text{C}$	64	A
I_{DM}	$T_C = 25^\circ\text{C}$, pulse width limited by T_{JM}	150	A
I_{AR}	$T_C = 25^\circ\text{C}$	64	A
E_{AR}	$T_C = 25^\circ\text{C}$	80	mJ
E_{AS}	$T_C = 25^\circ\text{C}$	2.5	J
dv/dt	$I_S \leq I_{DM}$, di/dt $\leq 100 \text{ A}/\mu\text{s}$, $V_{DD} \leq V_{DSS}$, $T_J \leq 150^\circ\text{C}$, $R_G = 4 \Omega$	20	V/ns
P_D	$T_C = 25^\circ\text{C}$	830	W
T_J		-55 ... +150	$^\circ\text{C}$
T_{JM}		150	$^\circ\text{C}$
T_{stg}		-55 ... +150	$^\circ\text{C}$
M_d	Mounting torque (TO-264)	1.13/10 Nm/lb.in.	
Weight	TO-264	10	g
	PLUS247	6	g
T_L	1.6 mm (0.062 in.) from case for 10 s	300	$^\circ\text{C}$
T_{SOLD}	Plastic body for 10 s	260	$^\circ\text{C}$

TO-264 (IXFK)

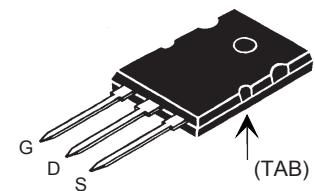

PLUS247 (IXFX)

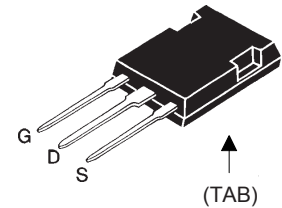

G = Gate D = Drain
 S = Source Tab = Drain

Features

- | International standard packages
- | Fast recovery diode
- | Unclamped Inductive Switching (UIS) rated
- | Low package inductance
- easy to drive and to protect

Advantages

- | Easy to mount
- | Space savings
- | High power density

Symbol	Test Conditions ($T_J = 25^\circ\text{C}$, unless otherwise specified)	Characteristic Values		
		Min.	Typ.	Max.
BV_{DSS}	$V_{GS} = 0 \text{ V}$, $I_D = 250 \mu\text{A}$	500		V
$V_{GS(th)}$	$V_{DS} = V_{GS}$, $I_D = 8 \text{ mA}$	3.0		5.5 V
I_{GSS}	$V_{GS} = \pm 30 \text{ V}_{DC}$, $V_{DS} = 0$			$\pm 200 \text{ nA}$
I_{DSS}	$V_{DS} = V_{DSS}$ $V_{GS} = 0 \text{ V}$ $T_J = 125^\circ\text{C}$			25 μA
				1000 μA
$R_{DS(on)}$	$V_{GS} = 10 \text{ V}$, $I_D = 0.5 I_{D25}$ Pulse test, $t \leq 300 \mu\text{s}$, duty cycle $d \leq 2 \%$			85 $\text{m}\Omega$

Symbol	Test Conditions	Characteristic Values ($T_J = 25^\circ\text{C}$, unless otherwise specified)		
		Min.	Typ.	Max.
g_{fs}	$V_{DS} = 20\text{ V}; I_D = 0.5 I_{D25}$, pulse test	30	50	S
C_{iss}	$V_{GS} = 0\text{ V}, V_{DS} = 25\text{ V}, f = 1\text{ MHz}$		8700	pF
C_{oss}			970	pF
C_{rss}			90	pF
$t_{d(on)}$	$V_{GS} = 10\text{ V}, V_{DS} = 0.5 V_{DSS}, I_D = 0.5 I_{D25}$ $R_G = 2\ \Omega$ (External)		30	ns
t_r			25	ns
$t_{d(off)}$			85	ns
t_f			22	ns
$Q_{g(on)}$	$V_{GS} = 10\text{ V}, V_{DS} = 0.5 V_{DSS}, I_D = 0.5 I_{D25}$		150	nC
Q_{gs}			50	nC
Q_{gd}			50	nC
R_{thJC}			0.15	$^\circ\text{C/W}$
R_{thCS}		0.15		$^\circ\text{C/W}$

Source-Drain Diode		Characteristic Values ($T_J = 25^\circ\text{C}$, unless otherwise specified)		
Symbol	Test Conditions	Min.	Typ.	Max.
I_S	$V_{GS} = 0\text{ V}$			64 A
I_{SM}	Repetitive			150 A
V_{SD}	$I_F = I_S, V_{GS} = 0\text{ V}$, Pulse test, $t \leq 300\ \mu\text{s}$, duty cycle $d \leq 2\%$			1.5 V
t_{rr}	$I_F = 25\text{ A}, -di/dt = 100\text{ A}/\mu\text{s}$ $V_R = 100\text{ V}$			200 ns
Q_{RM}			0.6	μC
I_{RM}			6.0	A

PLUS 247™ (IXFX) Outline

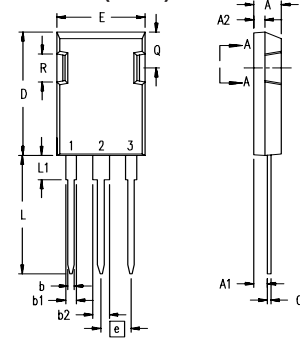

Terminals: 1 - Gate
2 - Drain (Collector)
3 - Source (Emitter)
4 - Drain (Collector)

Dim.	Millimeter		Inches	
	Min.	Max.	Min.	Max.
A	4.83	5.21	.190	.205
A ₁	2.29	2.54	.090	.100
A ₂	1.91	2.16	.075	.085
b	1.14	1.40	.045	.055
b ₁	1.91	2.13	.075	.084
b ₂	2.92	3.12	.115	.123
C	0.61	0.80	.024	.031
D	20.80	21.34	.819	.840
E	15.75	16.13	.620	.635
e	5.45 BSC		.215 BSC	
L	19.81	20.32	.780	.800
L1	3.81	4.32	.150	.170
Q	5.59	6.20	.220	0.244
R	4.32	4.83	.170	.190

TO-264 (IXFK) Outline

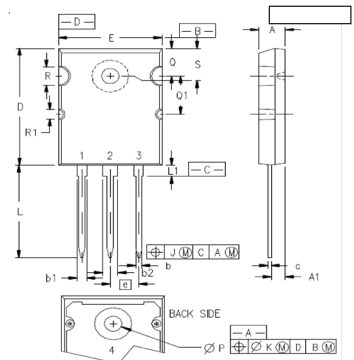

1 - GATE
2, 4 - DRAIN (COLLECTOR)
3 - SOURCE (EMITTER)

SYM	INCHES		MILLIMETERS	
	MIN	MAX	MIN	MAX
A	.185	.209	4.70	5.31
A1	.102	.118	2.59	3.00
b	.037	.055	0.94	1.40
b1	.087	.102	2.21	2.59
b2	.110	.126	2.79	3.20
c	.017	.029	0.43	0.74
D	1.007	1.047	25.58	26.59
E	.760	.799	19.30	20.29
e	.215BSC		5.46 BSC	
J	.000	.010	0.00	0.25
K	.000	.010	0.00	0.25
L	.779	.842	19.79	21.39
L1	.087	.102	2.21	2.59
ØP	.122	.138	3.10	3.51
Q	.240	.256	6.10	6.50
Q1	.330	.346	8.38	8.79
ØR	.155	.187	3.94	4.75
ØR1	.085	.093	2.16	2.36
S	.243	.253	6.17	6.43

IXYS reserves the right to change limits, test conditions, and dimensions.

IXYS MOSFETs and IGBTs are covered by 4,835,592 4,931,844 5,049,961 5,237,481 6,162,665 6,404,065 B1 6,683,344 6,727,585
one or more of the following U.S. patents: 4,850,072 5,017,508 5,063,307 5,381,025 6,259,123 B1 6,534,343 6,710,405B2 6,759,692
4,881,106 5,034,796 5,187,117 5,486,715 6,306,728 B1 6,583,505 6,710,463 6,771,478 B2

Fig. 1. Output Characteristics
@ 25°C

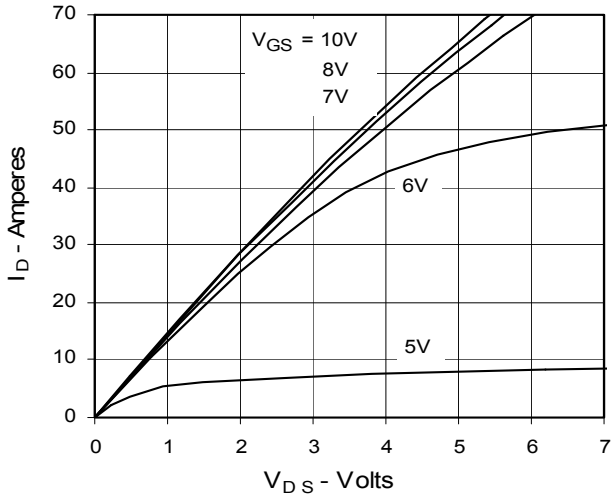

Fig. 2. Extended Output Characteristics
@ 25°C

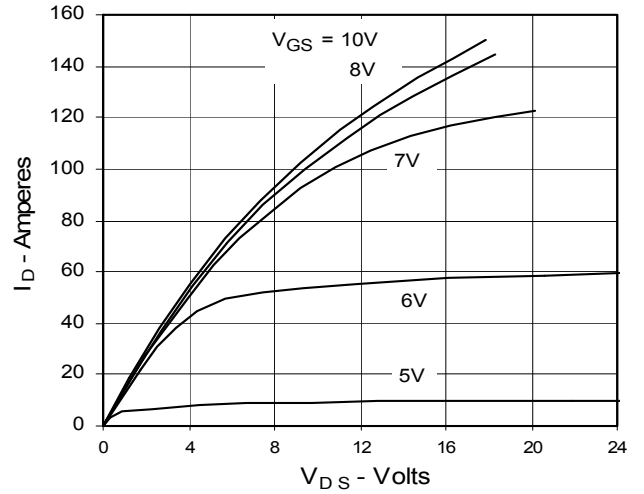

Fig. 3. Output Characteristics
@ 125°C

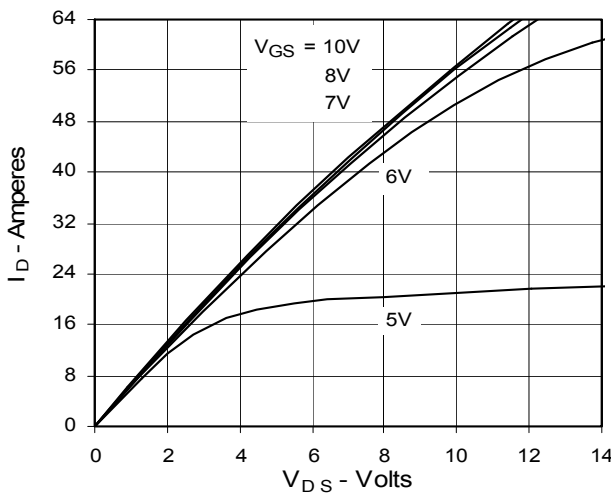

Fig. 4. $R_{DS(on)}$ Normalized to 0.5 I_{D25} Value vs. Junction Temperature

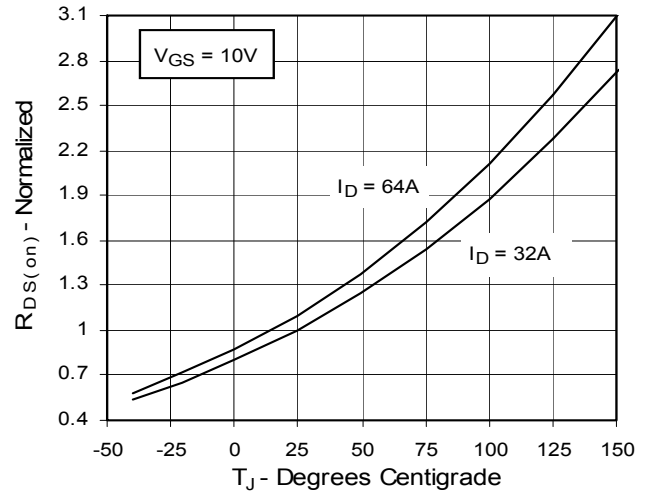

Fig. 5. $R_{DS(on)}$ Normalized to 0.5 I_{D25} Value vs. I_D

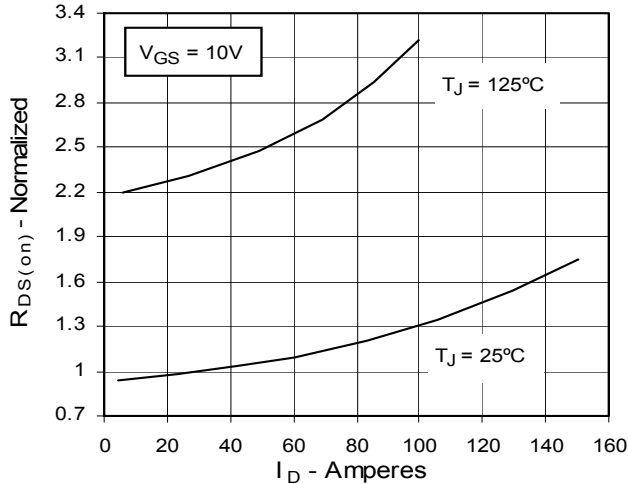

Fig. 6. Drain Current vs. Case Temperature

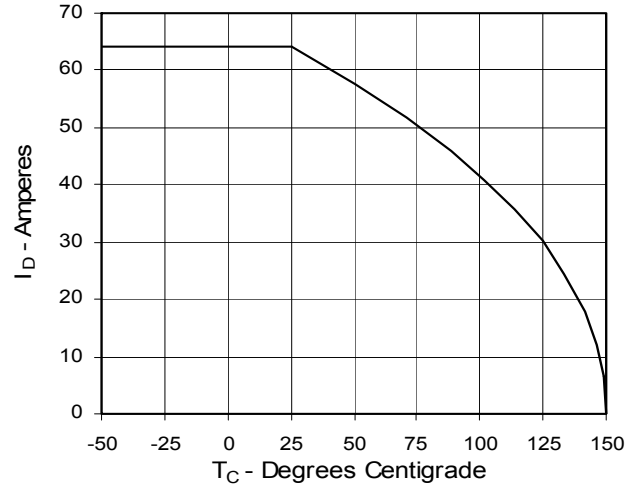

Fig. 7. Input Admittance

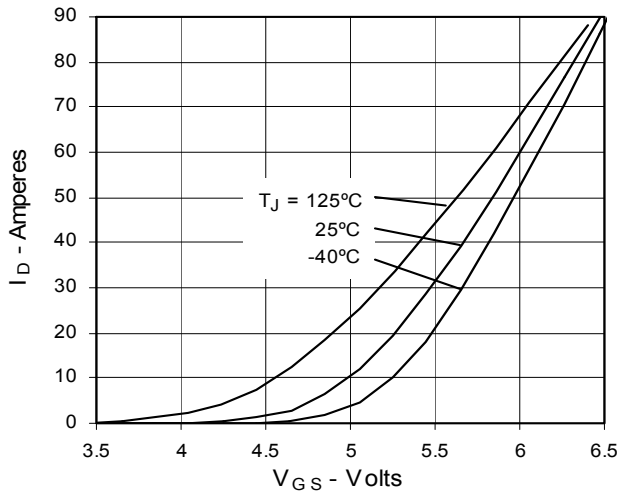

Fig. 8. Transconductance

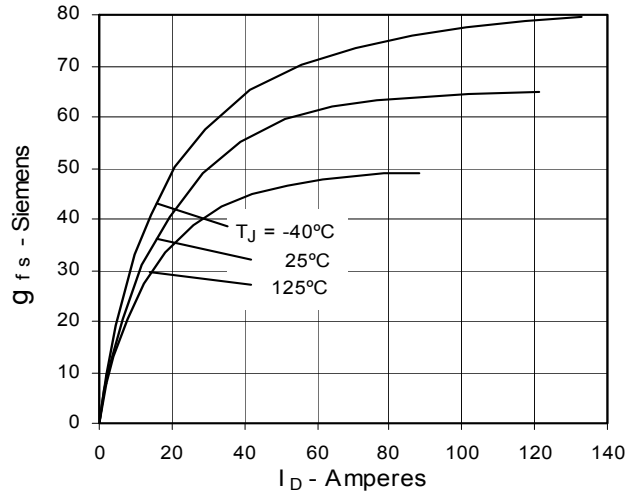

Fig. 9. Source Current vs. Source-To-Drain Voltage

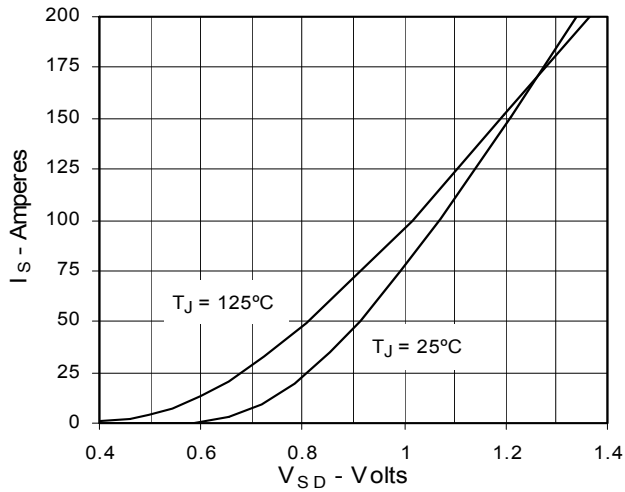

Fig. 10. Gate Charge

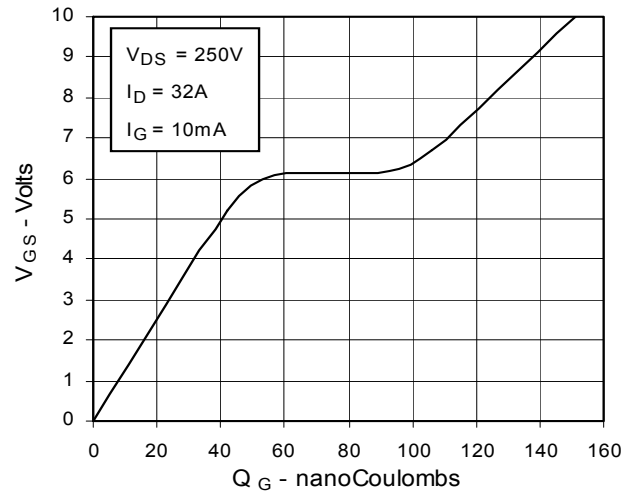

Fig. 11. Capacitance

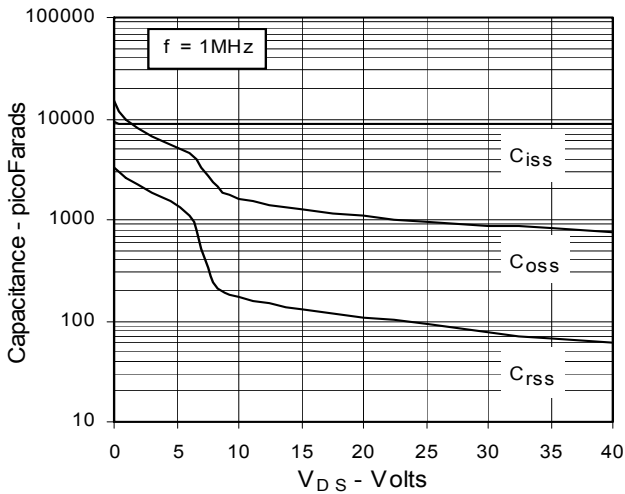

Fig. 12. Maximum Transient Thermal Resistance

